

“Evelien en Serge door Nederland”

Leidsche Flesch Ouderdag

2 april 2016

Hendrik Jan Hoogeboom
informatica (algoritmen/theorie)

trefwoorden: trein, Dijkstra

	A-KERKHOF GRONINGEN f 220.— A-KERKHOF GRONINGEN f 220.—		GROOTE MARKT GRONINGEN f 220.— GROOTE MARKT GRONINGEN f 220.—	HEERESTRAAT GRONINGEN f 240.— HEERESTRAAT GRONINGEN f 240.—	STATION "NOORD" f 200.— STATION "NOORD" f 200.—	SPUI "N-GRAVENHAGE" f 260.— SPUI "N-GRAVENHAGE" f 260.—	PLEIN "N-GRAVENHAGE" f 260.— PLEIN "N-GRAVENHAGE" f 260.—	WATERLEIDING f 150.— WATERLEIDING f 150.—	L. POTEN "N-GRAVENHAGE" f 280.— L. POTEN "N-GRAVENHAGE" f 280.—	
--	--	--	--	--	--	--	--	--	--	--

VREEBURG UTRECHT f 200.— VREEBURG UTRECHT f 200.—	BILTSTRAAT UTRECHT f 180.— BILTSTRAAT UTRECHT f 180.—	ALGEMEEN FONDS	NEUDE UTRECHT f 180.— NEUDE UTRECHT f 180.—	STATION "WEST" f 200.— STATION "WEST" f 200.—	HOUISTRAAT HAARLEM f 140.— HOUISTRAAT HAARLEM f 140.—	ZULWEG HAARLEM f 140.— ZULWEG HAARLEM f 140.—	ELECTRICITEIT- BEDRIJF f 100.— ELECTRICITEIT- BEDRIJF f 100.—	BARTELKOS- STRAAT HAARLEM f 140.— BARTELKOS- STRAAT HAARLEM f 140.—
--	--	-------------------	--	--	--	--	--	--

Ouderdag
2 apr '17 2016
Leidsche Flesch
ALGEMEEN FONDS

“Evelien en Serge
door Nederland”

KANS
Hendrik Jan
Hoogeboom
informatica

HOPPLEIN ROTTERDAM f 300.— HOPPLEIN ROTTERDAM f 300.—	B.L.A.K. ROTTERDAM f 300.— B.L.A.K. ROTTERDAM f 300.—	ALGEMEEN FONDS	COOLINGEL ROTTERDAM f 320.— COOLINGEL ROTTERDAM f 320.—	STATION "OOST" f 200.— STATION "OOST" f 200.—	KANS 	LEIDSCH- STRAAT AMSTERDAM f 350.— LEIDSCH- STRAAT AMSTERDAM f 350.—	EXTRA BELASTING + Beteel f 100.— EXTRA BELASTING + Beteel f 100.—	KALVERSTRAAT AMSTERDAM f 400.— KALVERSTRAAT AMSTERDAM f 400.—
--	--	-------------------	--	--	---	--	--	--



VELPERPLEIN f 120.— VELPERPLEIN f 120.—	KETELSTRAAT f 100.— KETELSTRAAT f 100.—	KANS 	STEENSTRAAT f 100.— STEENSTRAAT f 100.—	STATION "ZUID" f 200.— STATION "ZUID" f 200.—	INKOMSTEN BELASTING + Beteel f 200.—	B.R.I.N.K ONS DORP f 60.— B.R.I.N.K ONS DORP f 60.—	ALGEMEEN FONDS	DORPSTRAAT ONS DORP f 60.— DORPSTRAAT ONS DORP f 60.—
--	--	---	--	--	--	--	-------------------	--

ONTVANG
BIJ HET PAKKETS
1200.—
BALANS
AF

fundamenteel/wisk. ♠

fi1 discrete
wiskunde

continue
wiskunde 1&2

Lineaire
algebra 1&2

logica

systemen ♥

digitale
technieken

computer-
architectuur^{II}

softwarelijn ♣

programmeer-
methoden

programmeer-
technieken

algoritmiek

databases

datastructuren^{II}

ondersteunend

orientatie

studeren en
presenteren

micro-economie

organisatie en
strategie

marketing

celfysiologie

moleculaire
genetica

microbiologie

basispracticum

celbiologie

biochemie

'algoritmiek' state chart

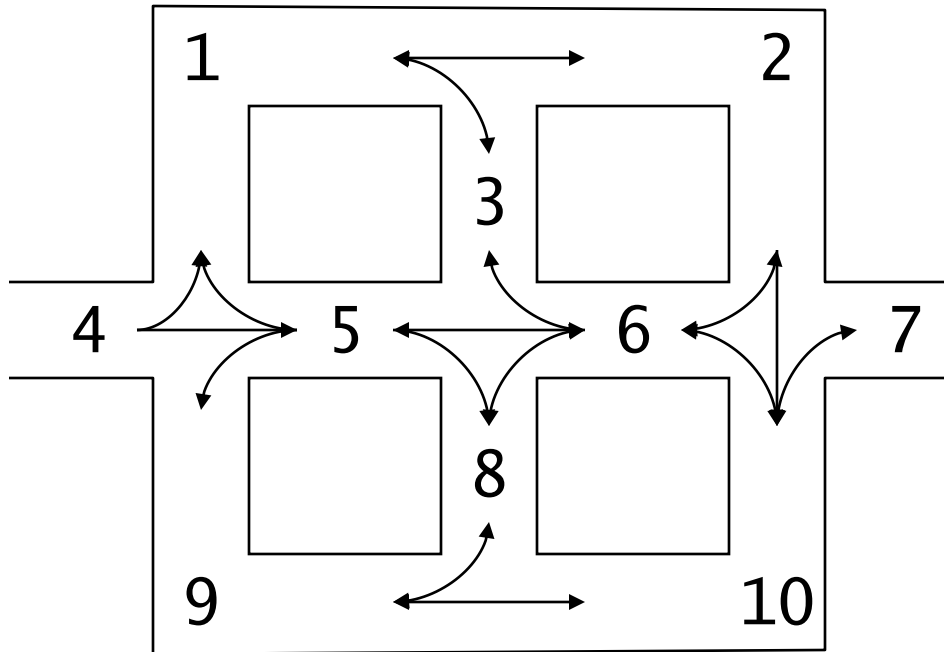

fundamentele informatica
'grafen'

'algoritmiek' state chart

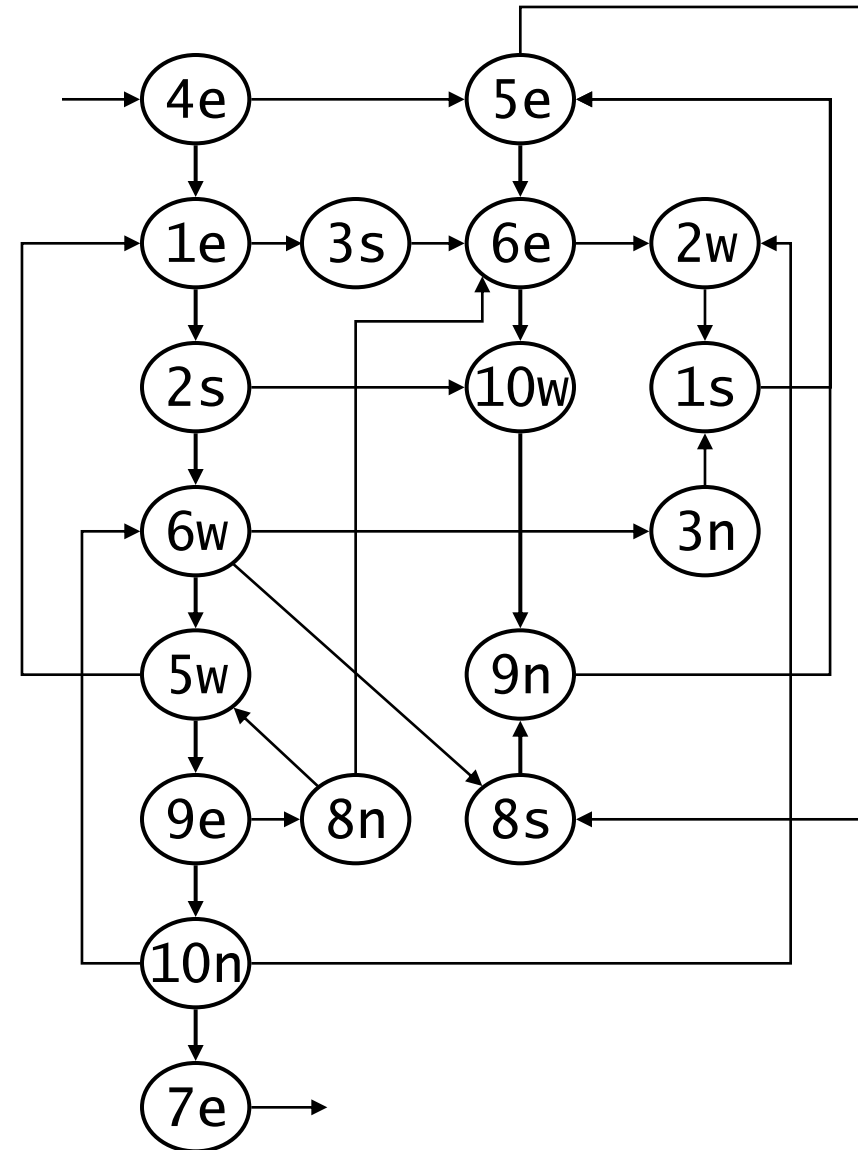
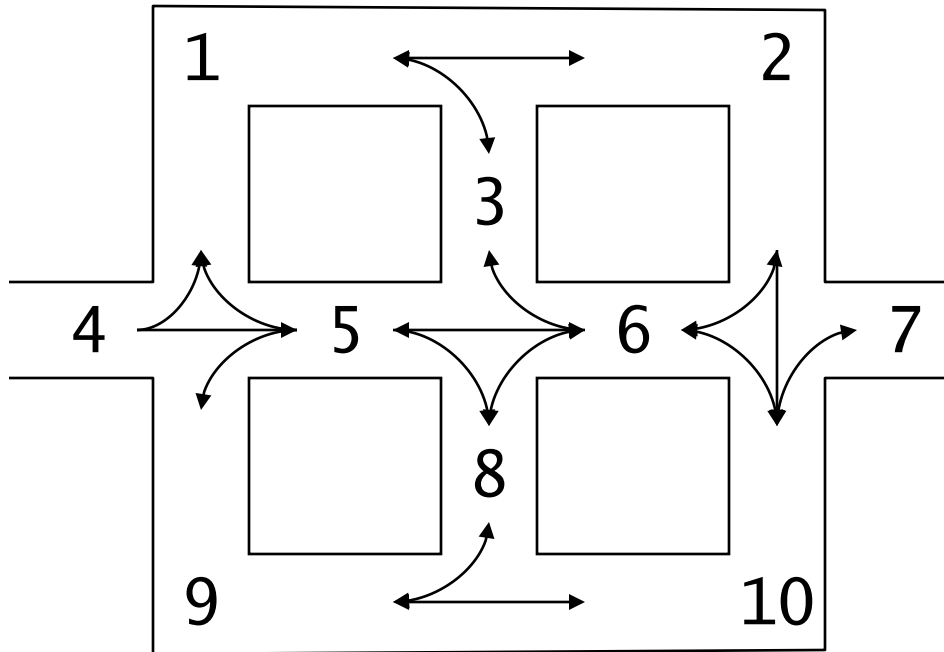

'algoritmiiek' state chart

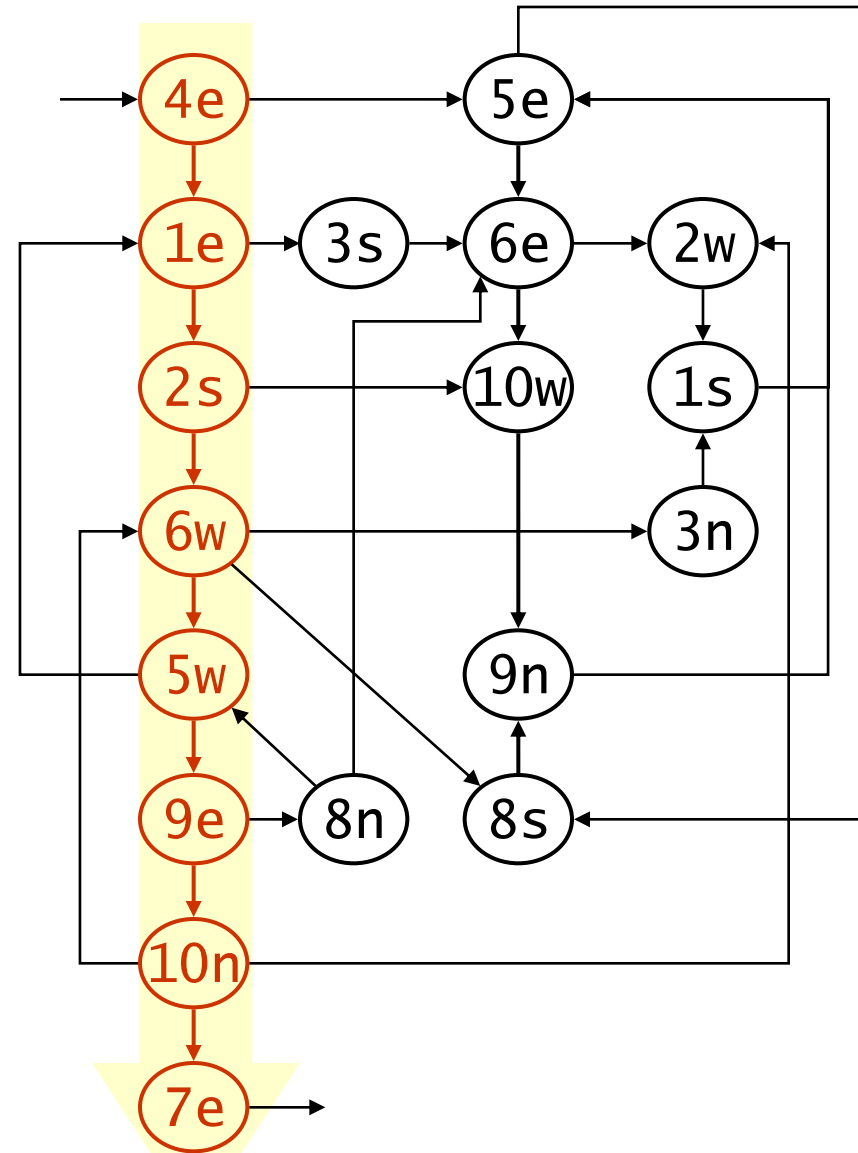
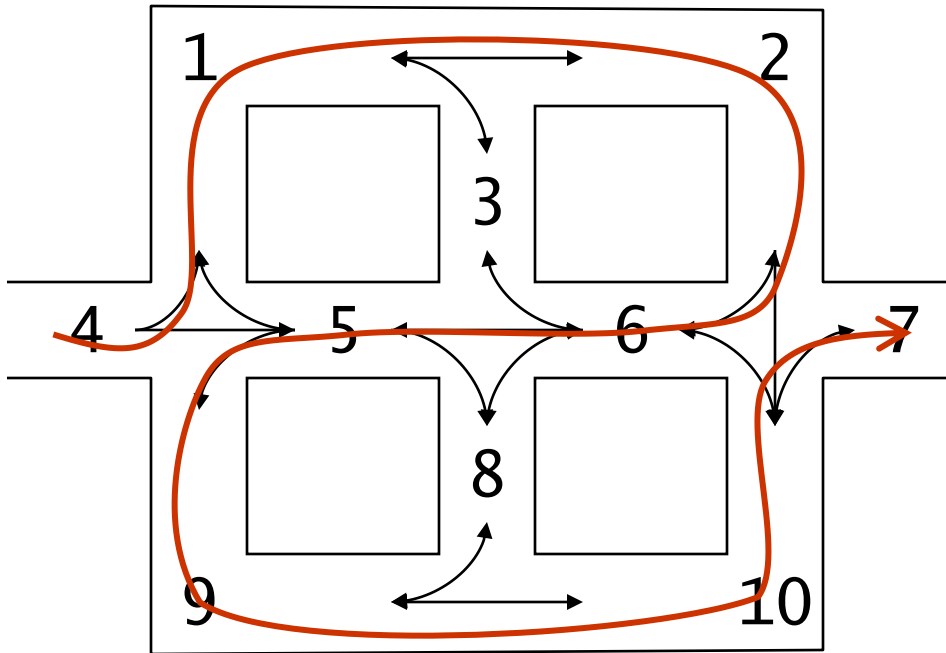

ja, maar ...

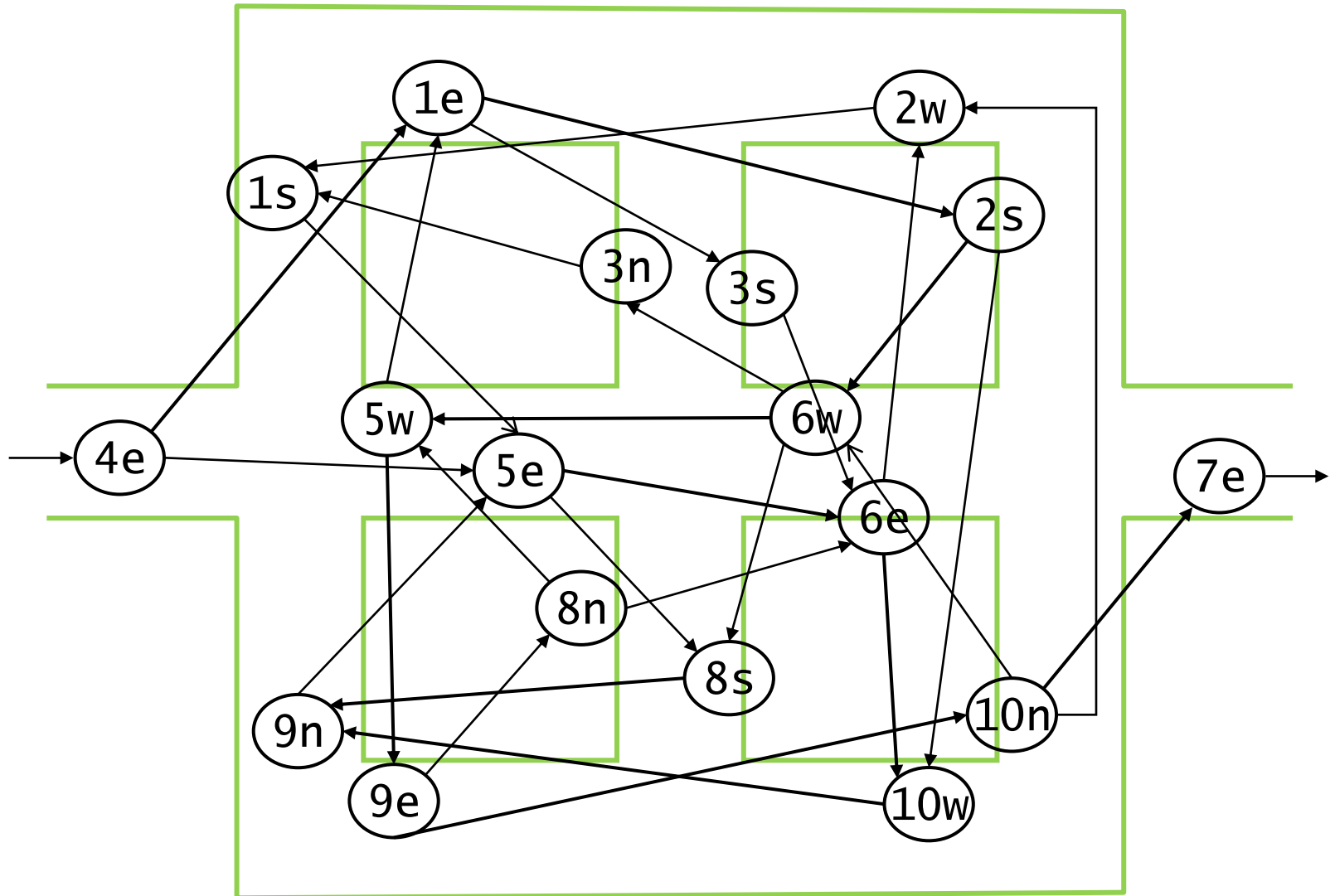

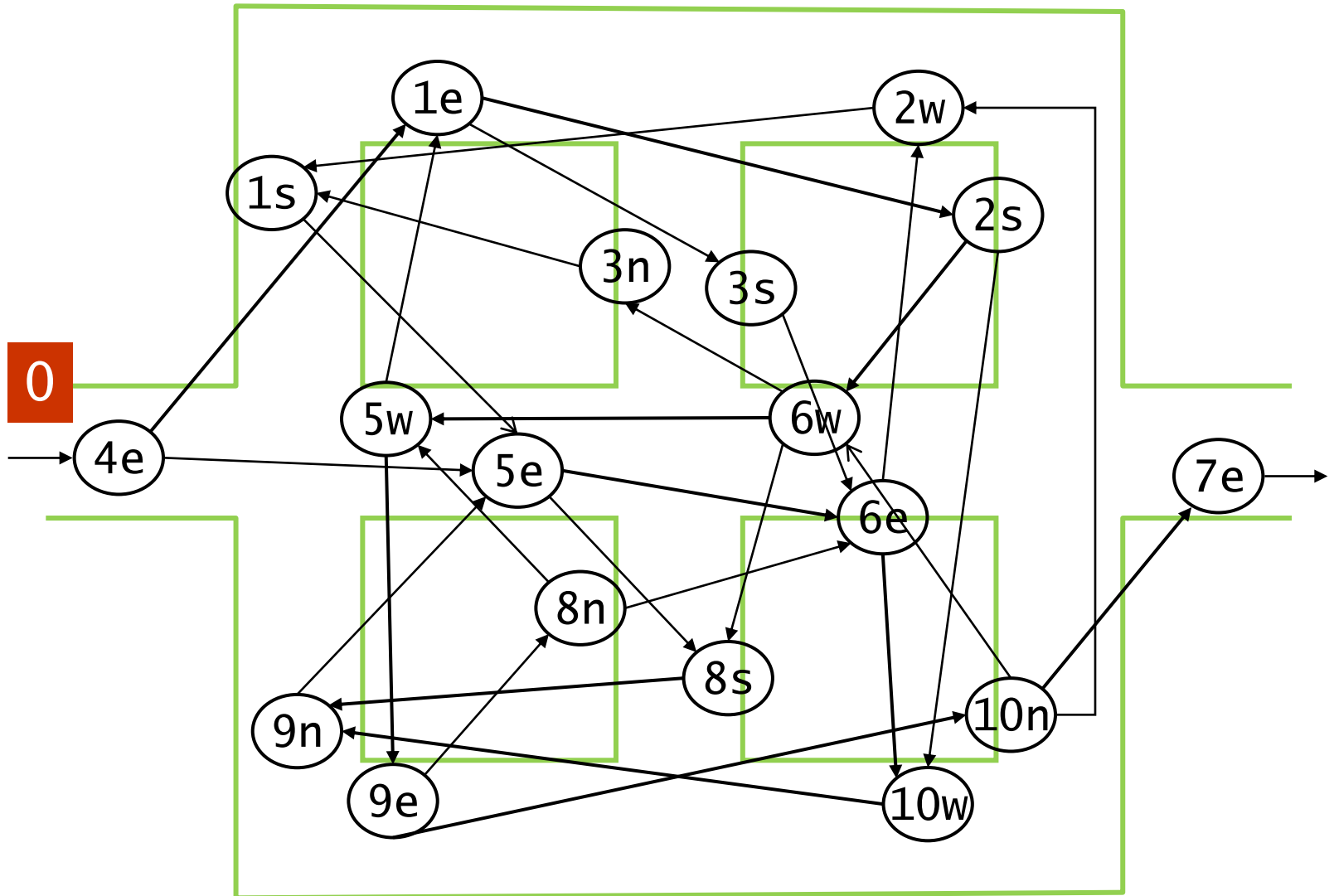

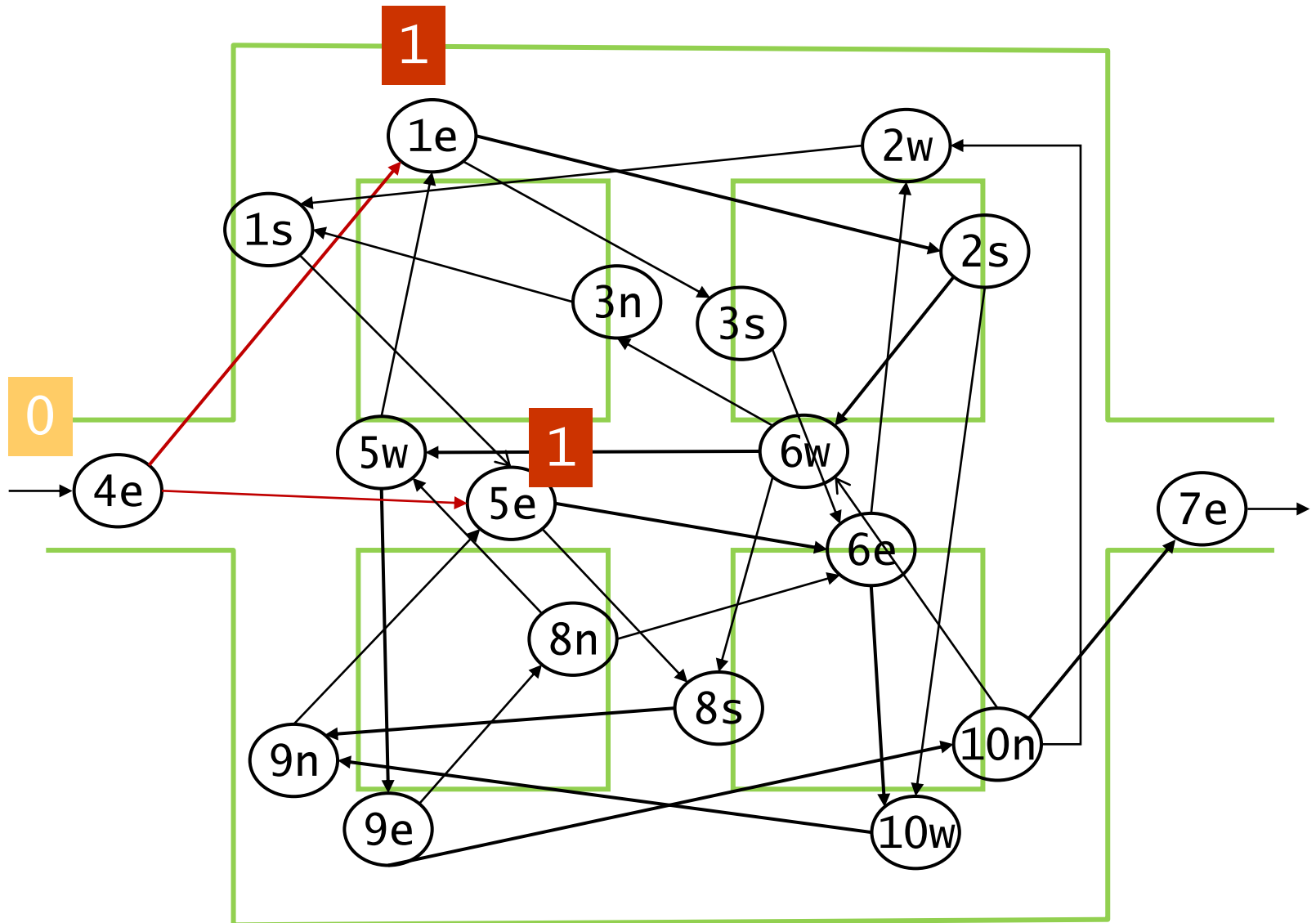

ja, maar ...

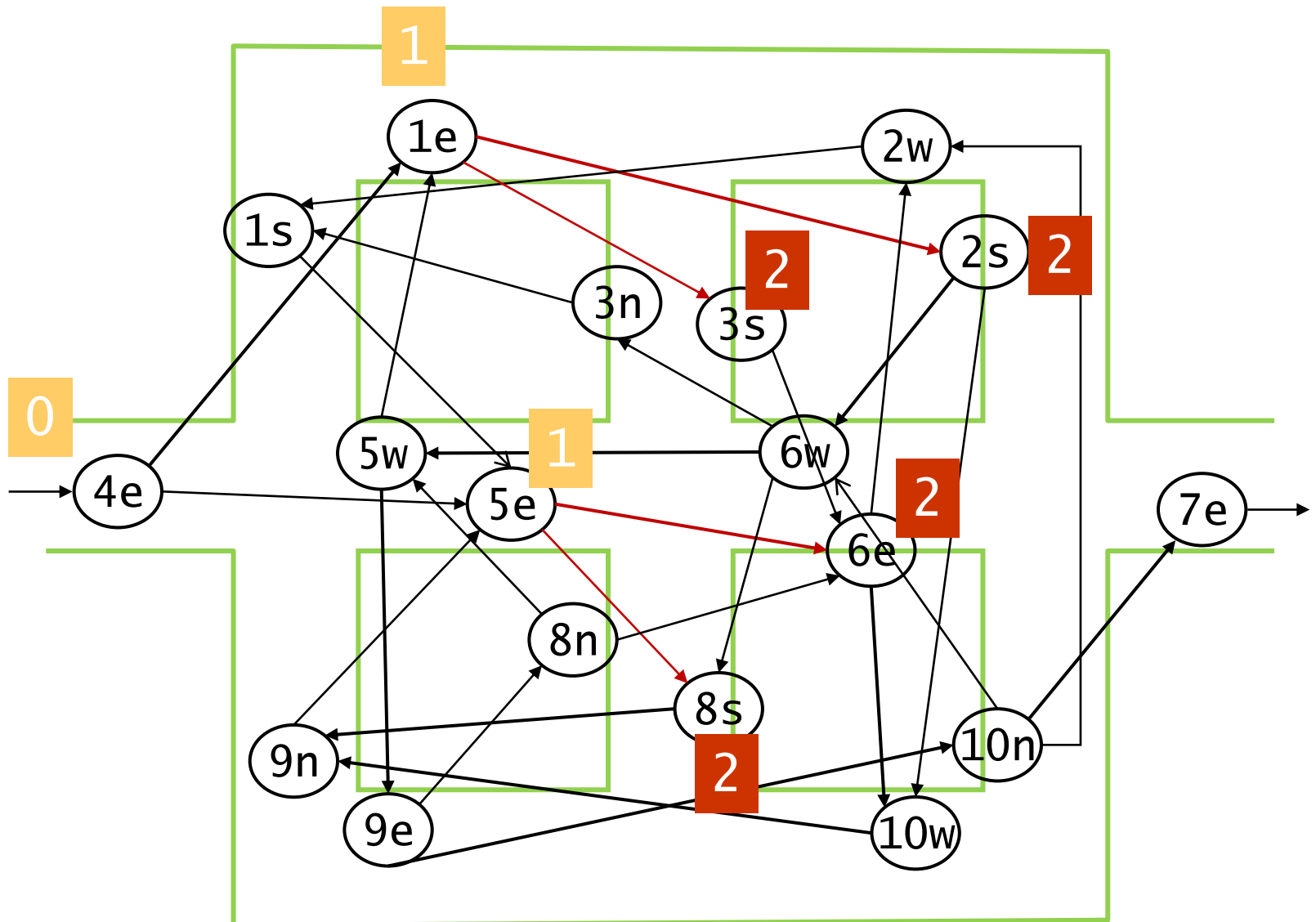

ja, maar ...

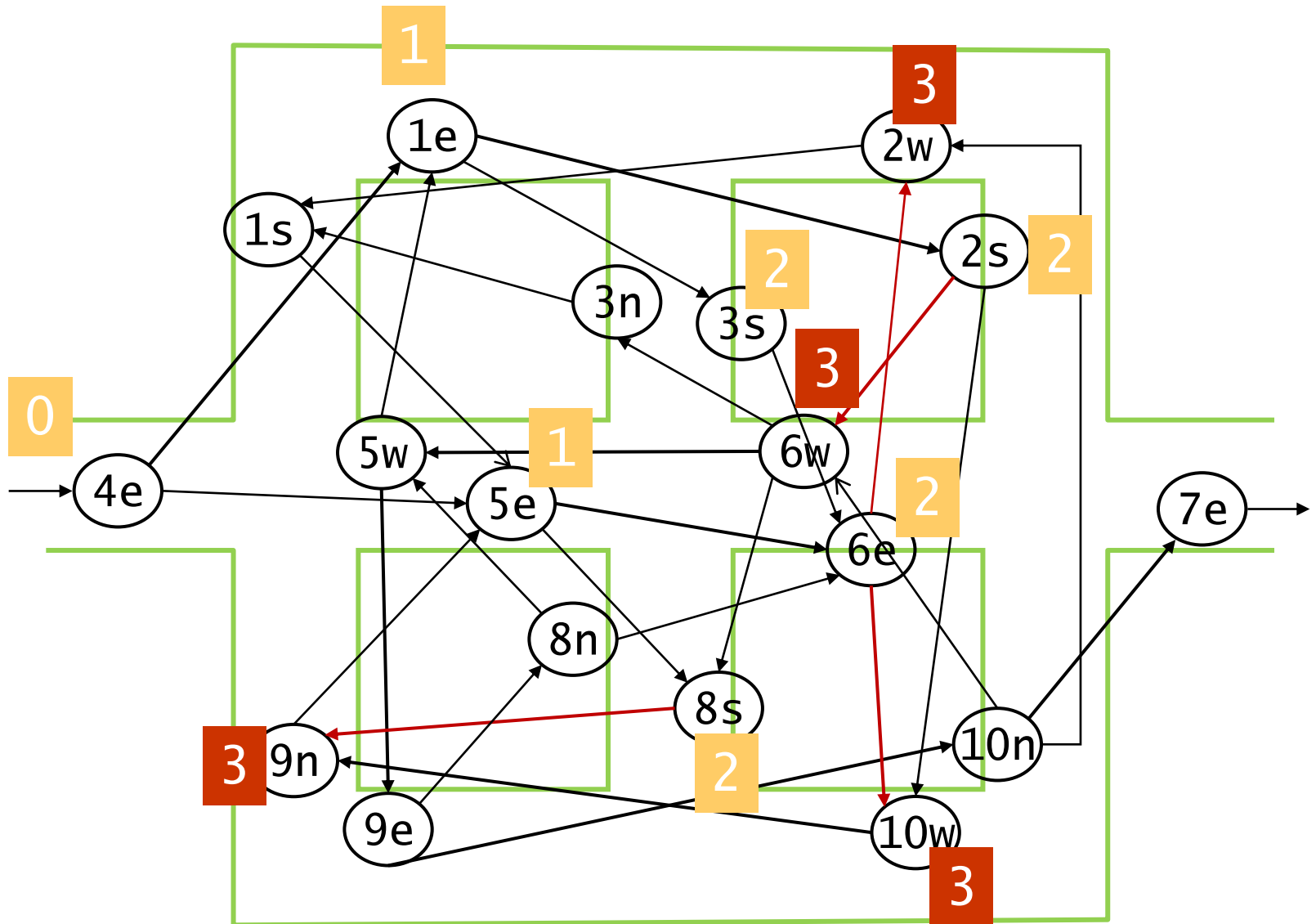

ja, maar ...

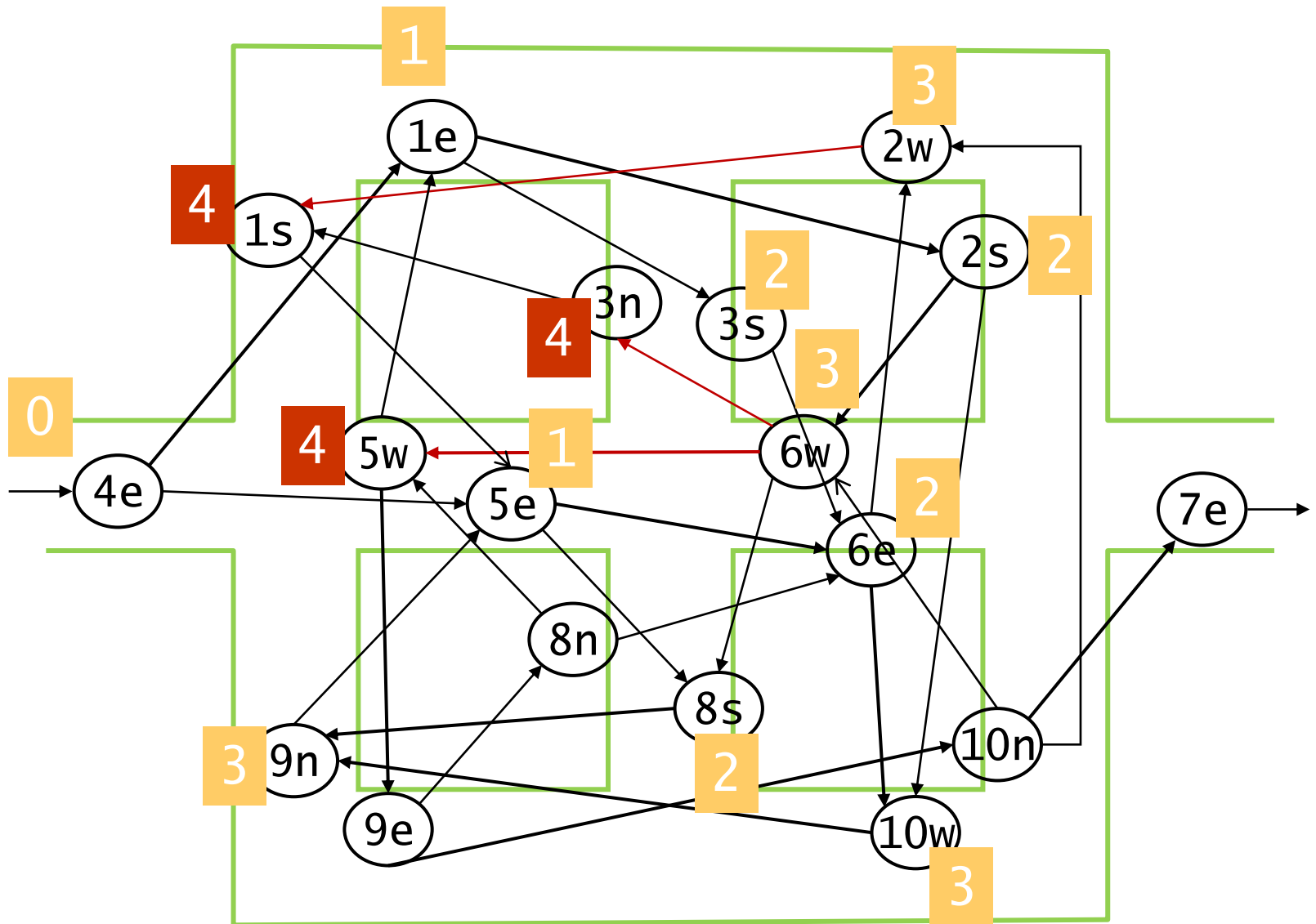

breadth first search !

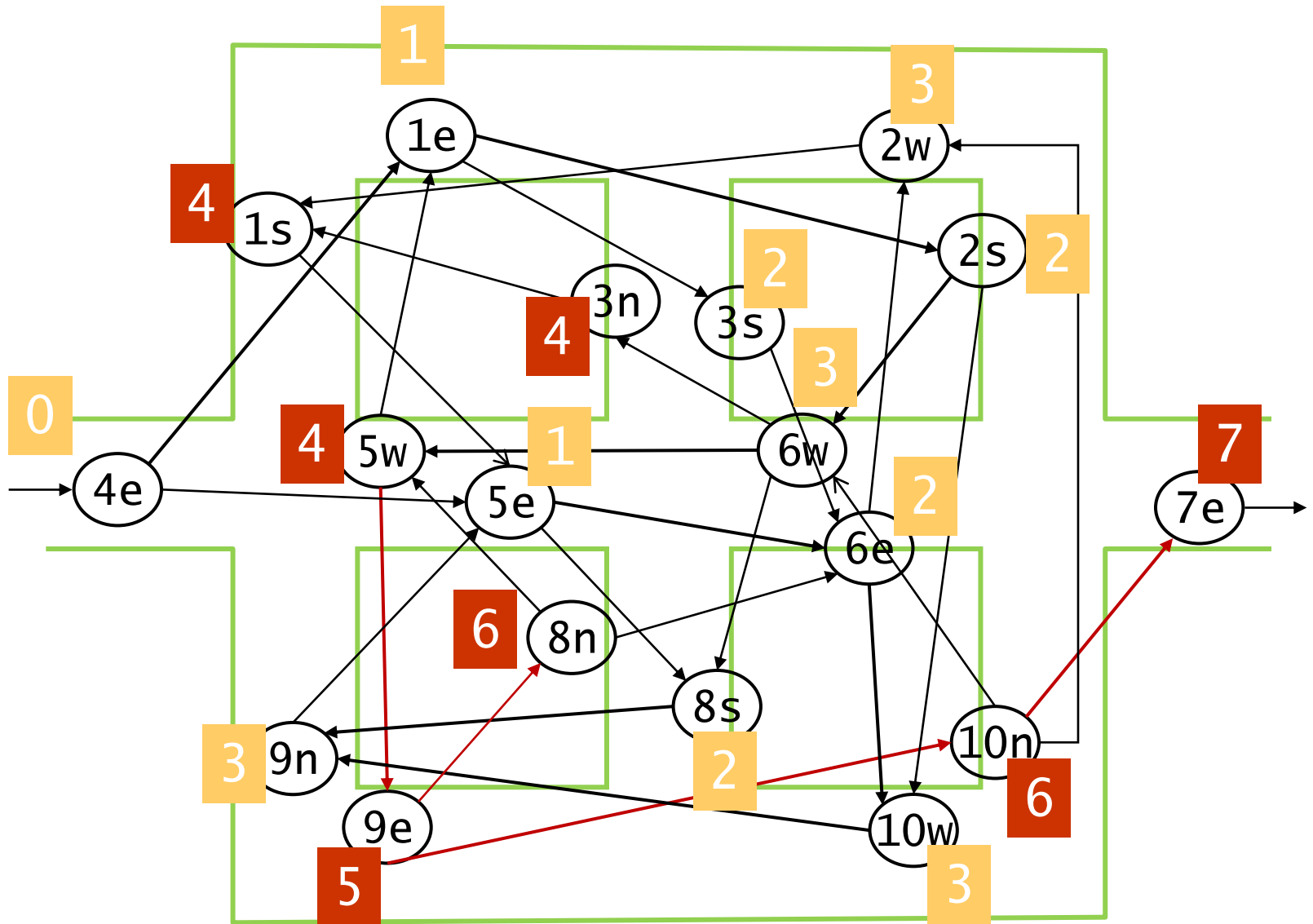

breadth first search !

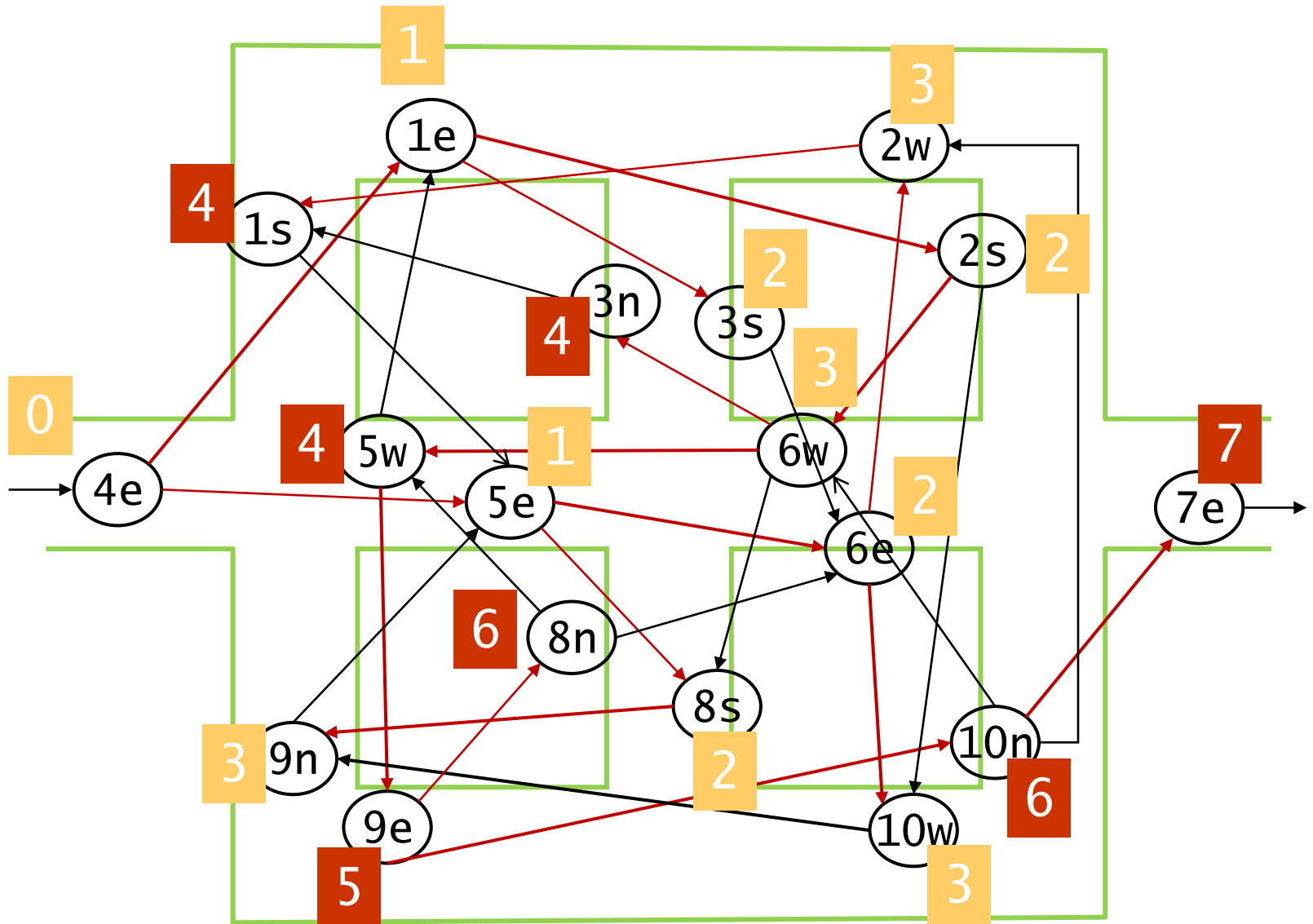

breadth first search !

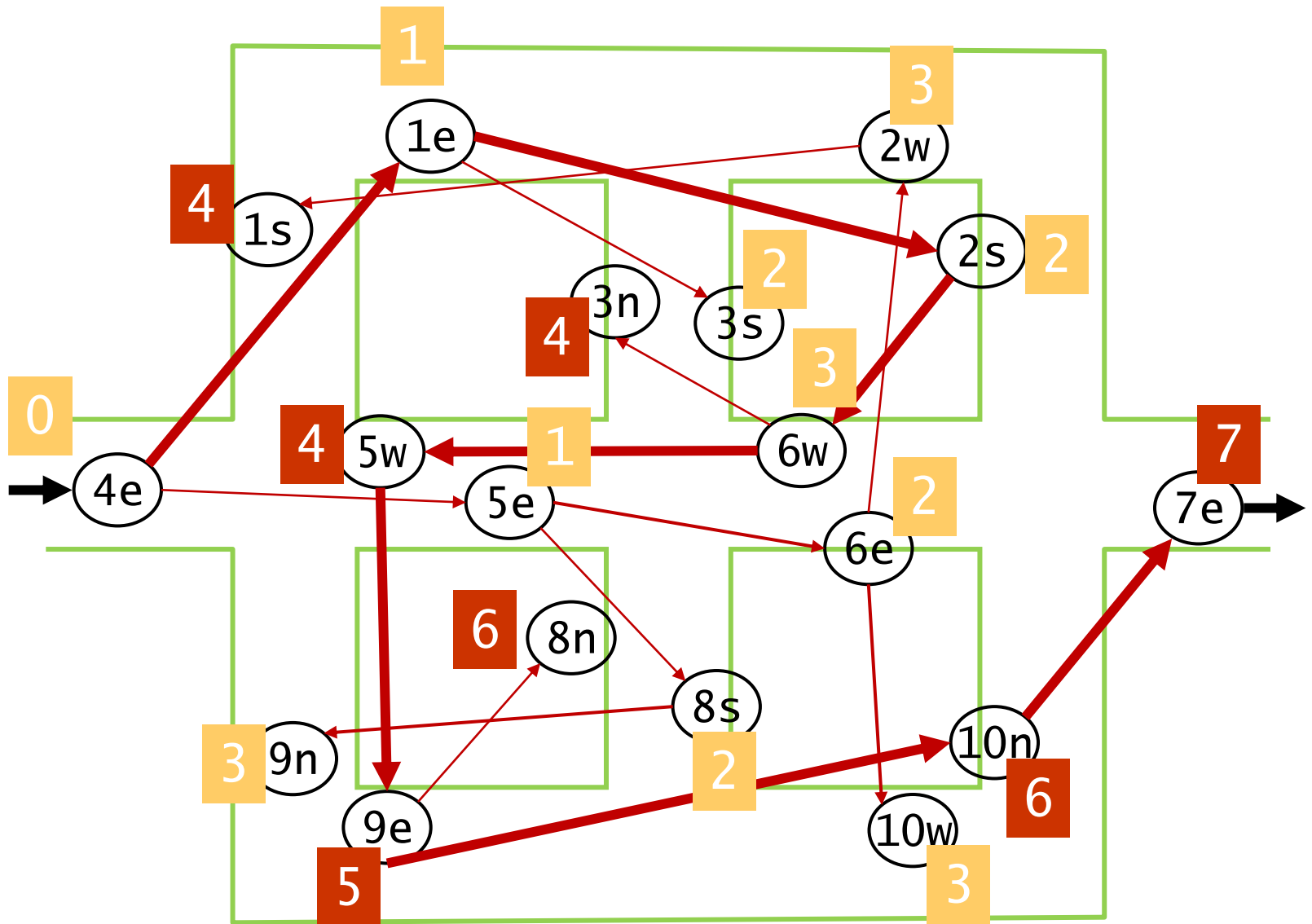

searching the state space

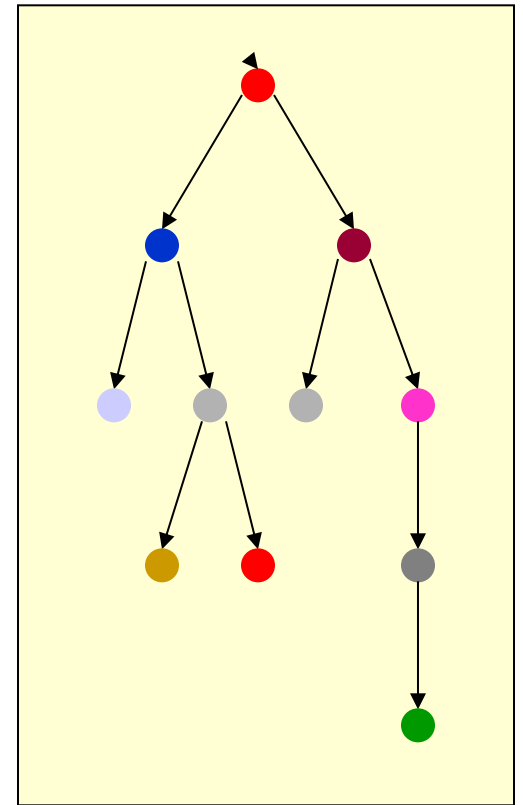
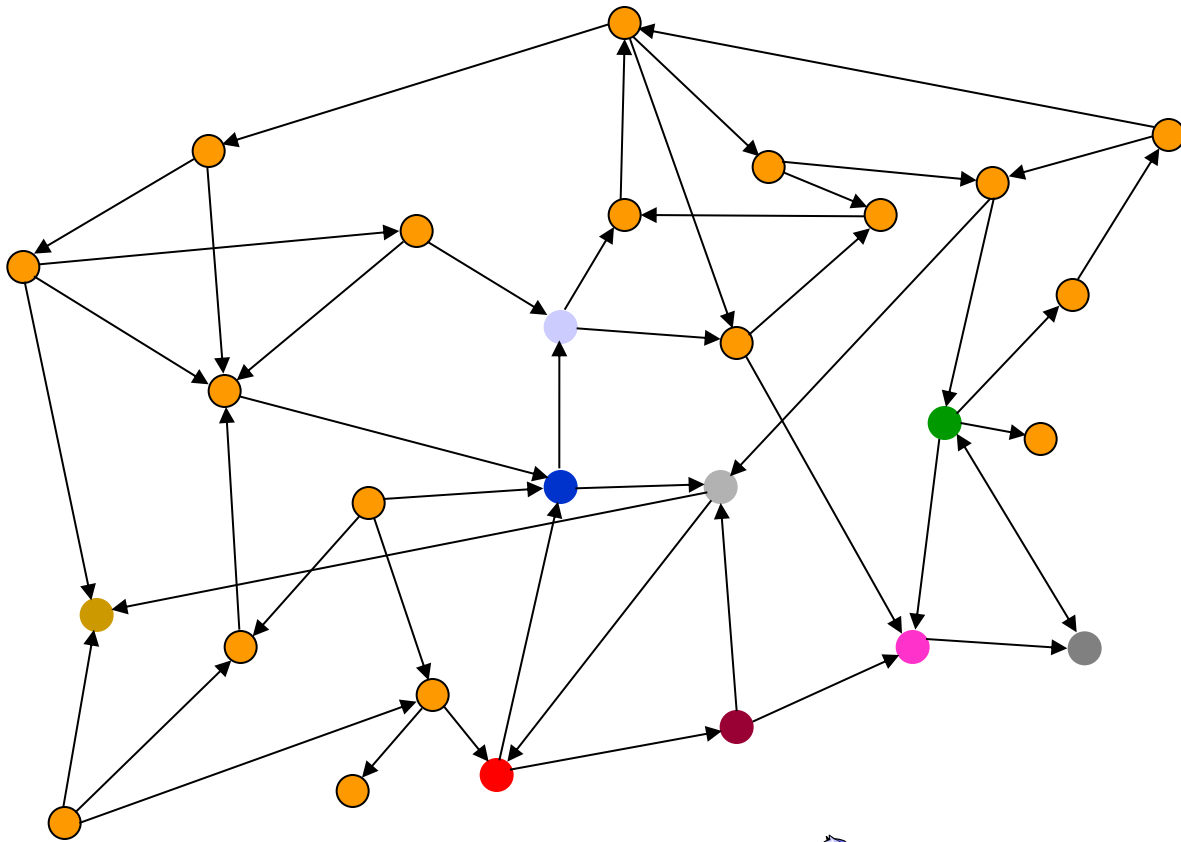

search tree

↑
heel veel
knopen

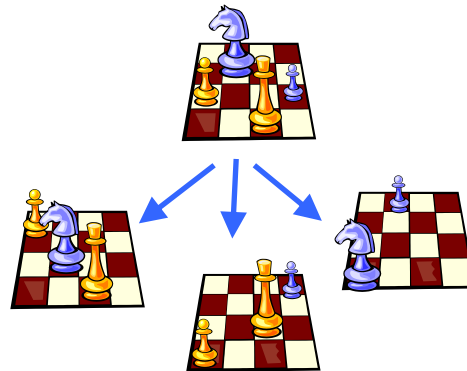

deep neural networks

nature International weekly journal of science

Home | News & Comment | Research | Careers & Jobs | Current Issue | Archive | Audio & Video | For

Archive > Volume 529 > Issue 7587 > Articles > Article

ARTICLE PREVIEW

[view full access options >](#)

NATURE | ARTICLE



日本語要約

Mastering the game of Go with deep neural networks and tree search

David Silver, Aja Huang, Chris J. Maddison, Arthur Guez, Laurent Sifre, George van den Driessche, Julian Schrittwieser, Ioannis Antonoglou, Veda Panneershelvam, Marc Lanctot, Sander Dieleman, Dominik Grewe, John Nham, Nal Kalchbrenner, Ilya Sutskever, Timothy Lillicrap, Madeleine Leach, Koray Kavukcuoglu, Thore Graepel & Demis Hassabis

[Affiliations](#) | [Contributions](#) | [Corresponding authors](#)

Nature 529, 484–489 (28 January 2016) | doi:10.1038/nature16961

Received 11 November 2015 | Accepted 05 January 2016 | Published online 27 January 2016

[Citation](#) | [Reprints](#) | [Rights & permissions](#) | [Article metrics](#)

Abstract

[Abstract](#) • [References](#) • [Author information](#) • [Extended data figures and tables](#) • [Supplementary information](#) • [Comments](#)

The game of Go has long been viewed as the most challenging of classic games for artificial intelligence owing to its enormous search space and the difficulty of evaluating board positions and moves. Here we introduce a new approach to computer Go that uses 'value networks' to evaluate board positions and 'policy networks' to select moves. These deep neural networks are trained by a novel combination of supervised learning from human expert games, and reinforcement learning from games of self-play. Without any lookahead search, the neural networks play Go at the level of state-of-the-art Monte Carlo tree search programs that simulate thousands of random games of

www.volkskrant.nl/tech/google-computer-wint-van-go-kampioen-in-best-of-five~a426202

Nieuws | Cultuur & Leven | **de Volkskrant**

Tech



Google-computer wint van go-kampioen in best-of-five

Ook in de derde ronde heeft AlphaGo, een computerprogramma van Google, gewonnen van regerend go-wereldkampioen Lee Se-dol. Daarmee heeft de computer de wedstrijd, een best-of-five, al gewonnen. De overwinning is een doorbraak in kunstmatige intelligentie.

Door: Redactie 12 maart 2016, 10:37



	A-KERKHOF GRONINGEN f 220.— A-KERKHOF GRONINGEN f 220.—		GROOTE MARKT GRONINGEN f 220.—	HEERESTRAAT GRONINGEN f 240.—	STATION "NOORD" f 200.— STATION "NOORD" f 200.—	SPUI "N-GRAVENHAGE" f 260.—	PLEIN "N-GRAVENHAGE" f 260.—	WATERLEIDING f 150.—	L. POTEN "N-GRAVENHAGE" f 280.—	
--	--	--	--------------------------------------	-------------------------------------	--	-----------------------------------	------------------------------------	-------------------------	---------------------------------------	--

VREEBURG UTRECHT f 200.—	BILTSTRAAT UTRECHT f 180.—	ALGEMEEN FONDS	NEUDE UTRECHT f 180.—	STATION "WEST" f 200.—	HOUISTRAAT HAARLEM f 140.—	ZULWEG HAARLEM f 140.—	ELECTRICITEIT- BEDRIJF f 100.—	BARTELKORIS- STRAAT HAARLEM f 140.—
--------------------------------	----------------------------------	-------------------	-----------------------------	------------------------------	----------------------------------	------------------------------	--------------------------------------	--

Ouderdag
2 apr '17 2016

Leidsche Flesch

ALGEMEEN FONDS

“Evelien en Serge
door Nederland”

Hendrik Jan
Hoogeboom

informatica

KANS

HOPPLEIN ROTTERDAM f 300.—	BLAAK ROTTERDAM f 300.—	ALGEMEEN FONDS	COOLINGEL ROTTERDAM f 320.—	STATION "OOST" f 200.—	KANS 	LEIDSCH- STRAAT AMSTERDAM f 350.—	EXTRA BELASTING + Beteel f 100.—	KALVERSTRAAT AMSTERDAM f 400.—
----------------------------------	-------------------------------	-------------------	-----------------------------------	------------------------------	---	--	--	--------------------------------------



VELPERPLEIN f 120.—	KETELSTRAAT f 100.—	KANS 
------------------------	------------------------	---

STEENSTRAAT f 100.—	STATION "ZUID" f 200.—
------------------------	------------------------------

INKOMSTEN BELASTING + Beteel f 200.—	BRINK ONS DORP f 60.—	ALGEMEEN FONDS
--	-----------------------------	-------------------

BRINK ONS DORP f 60.—	DORPSTRAAT ONS DORP f 60.—
-----------------------------	----------------------------------



“Evelien en Serge door Nederland”

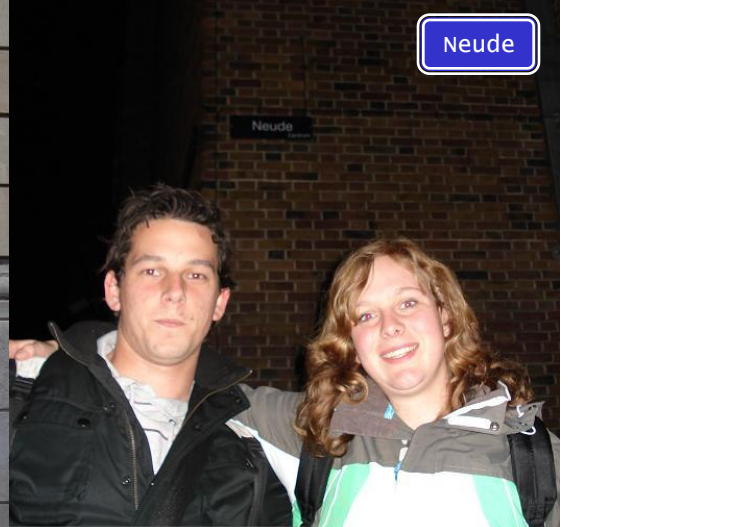

input ... output



Haarlem

Lees

Nieuwe reis →

Wijzig reis →

Terugreis plannen →

Vertrek 16:15 → Aankomst 19:14

Koop kaartje →

Zondag 18 april 20

Tijd	Station / Halte	Spoor	Richting	Reisdetails
16:15	Leiden Centraal	5a	Haarlem	Snelrein (NS)
16:34	Haarlem	1		
16:36	Haarlem	1	Amsterdam Centraal	Snelrein (NS)
16:52	Amsterdam Centraal	1		
16:57	Amsterdam Centraal	10b	Hilversum	Intercity (NS)
17:31	Amersfoort	5b		
17:38	Amersfoort	2	Zwolle	Intercity (NS)
19:14	Groningen	3b		

Toon tussenstations

© 2010 NS / ProR

hoe kom ik er?



Numerische Mathematik 1, 269–271 (1959)



A Note on Two Problems in Connexion with Graphs

By

E. W. DIJKSTRA

We consider n points (nodes), some or all pairs of which are connected by a branch; the length of each branch is given. We restrict ourselves to the case where at least one path exists between any two nodes. We now consider two problems.

Problem 2. Find the path of minimum total length between two given nodes P and Q .

From Wikipedia, the free encyclopedia

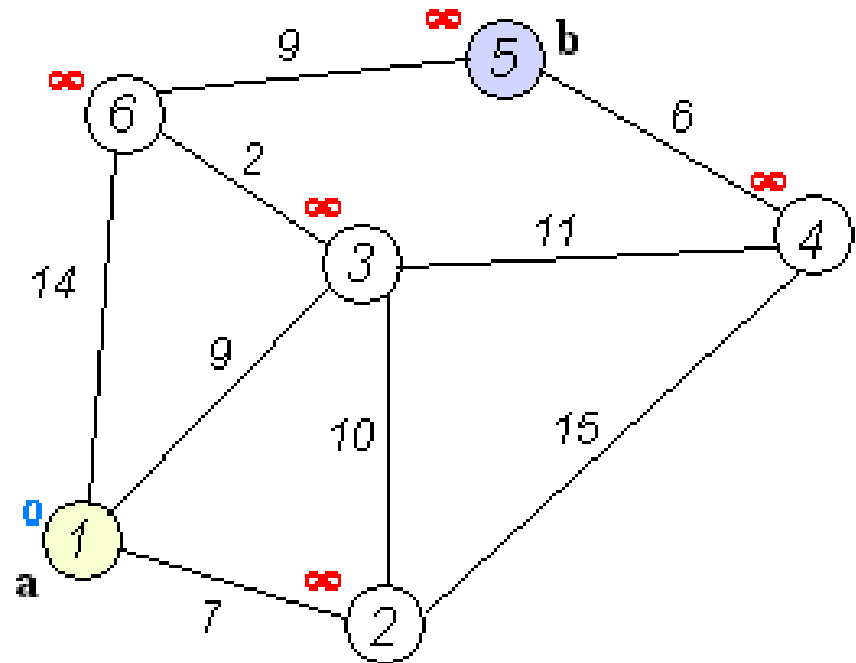

From Wikipedia, the free encyclopedia

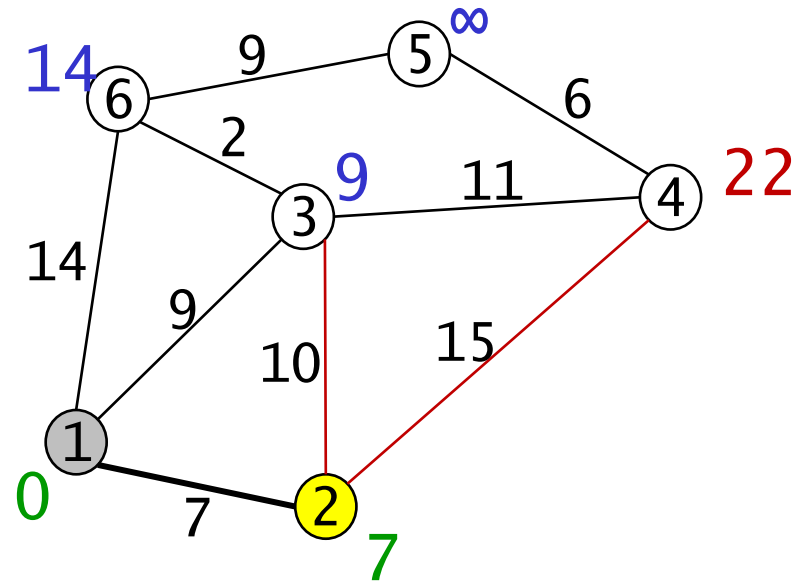
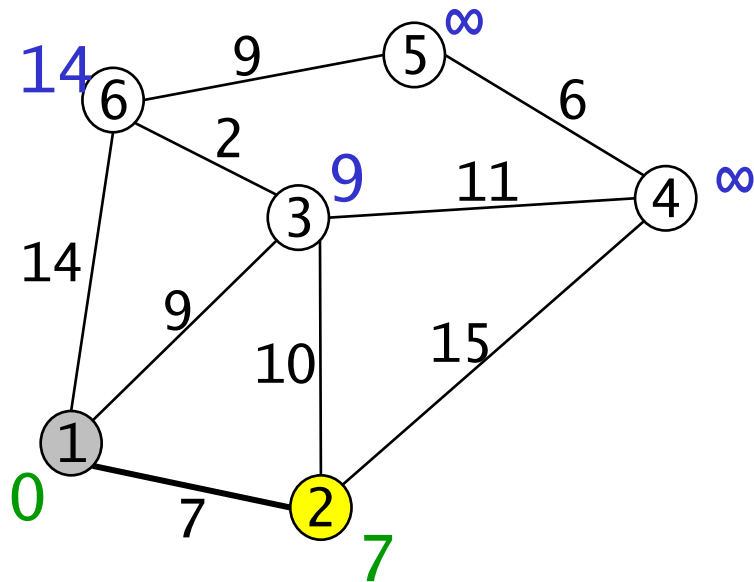
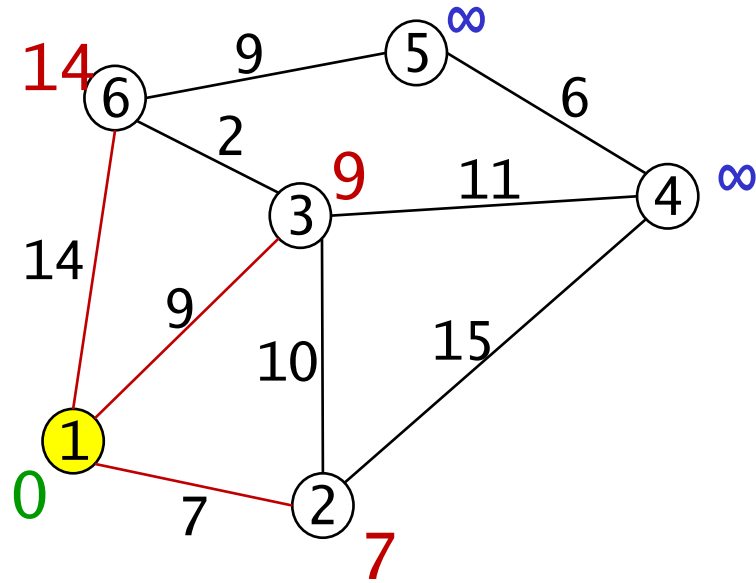
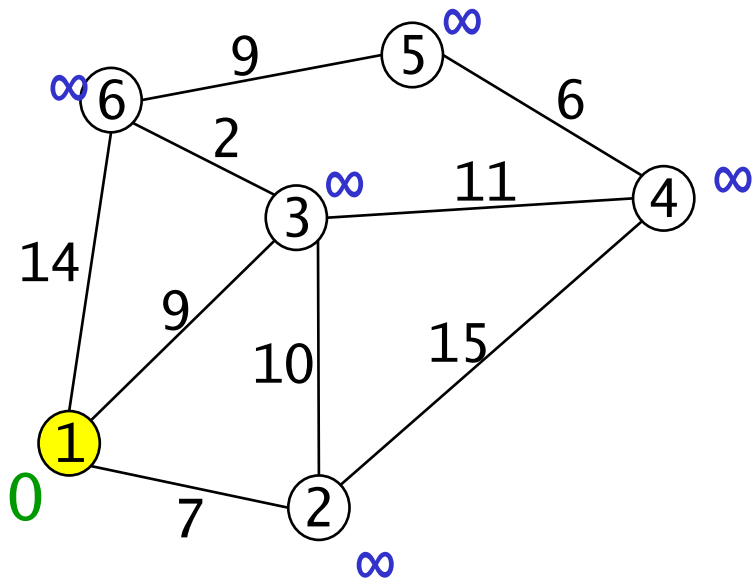

From Wikipedia, the free encyclopedia

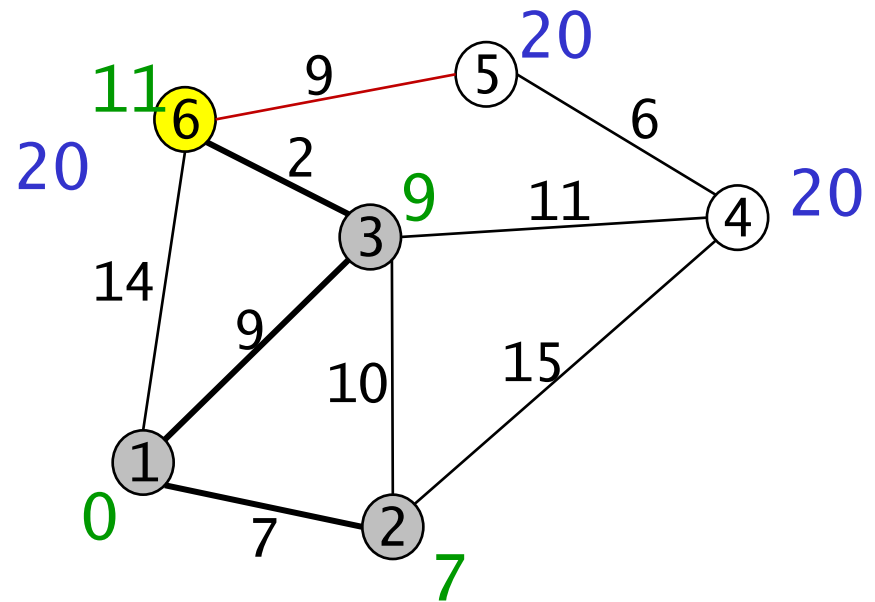
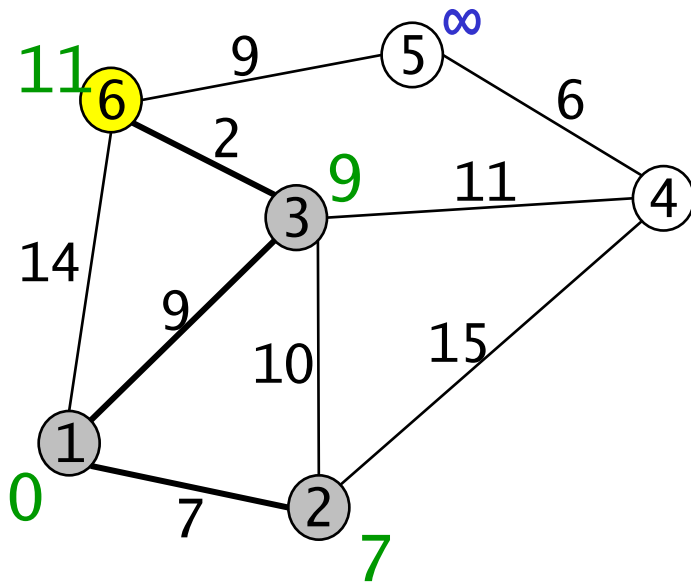
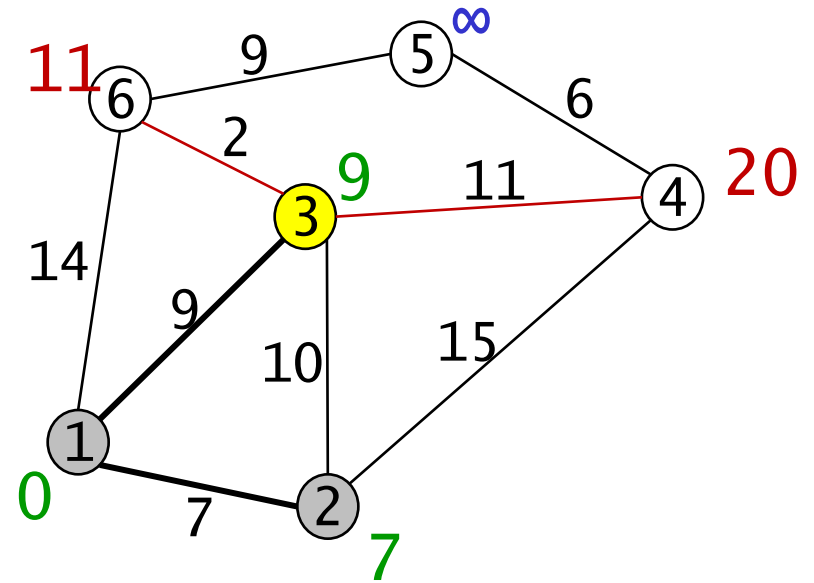
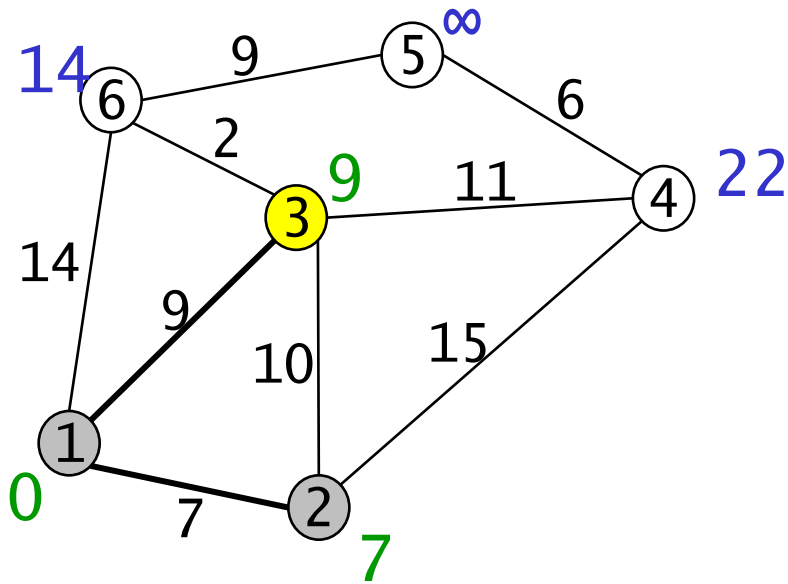

From Wikipedia, the free encyclopedia

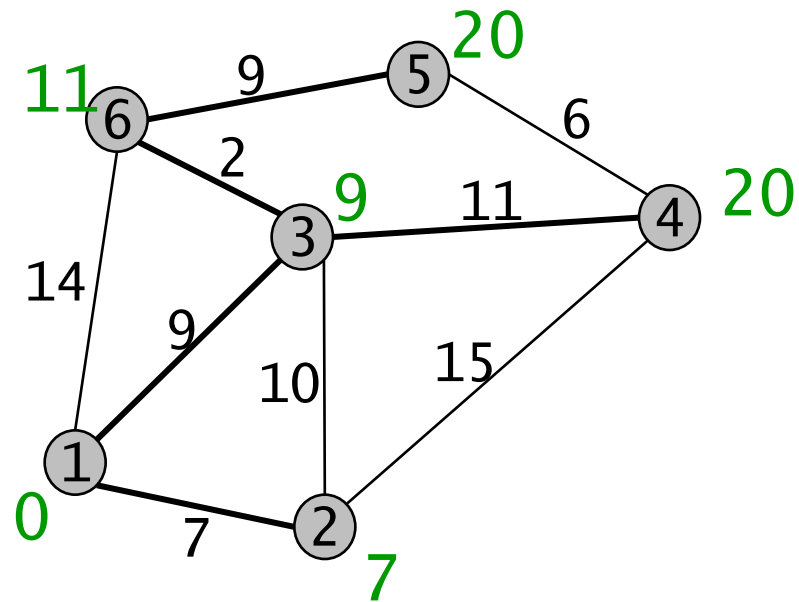
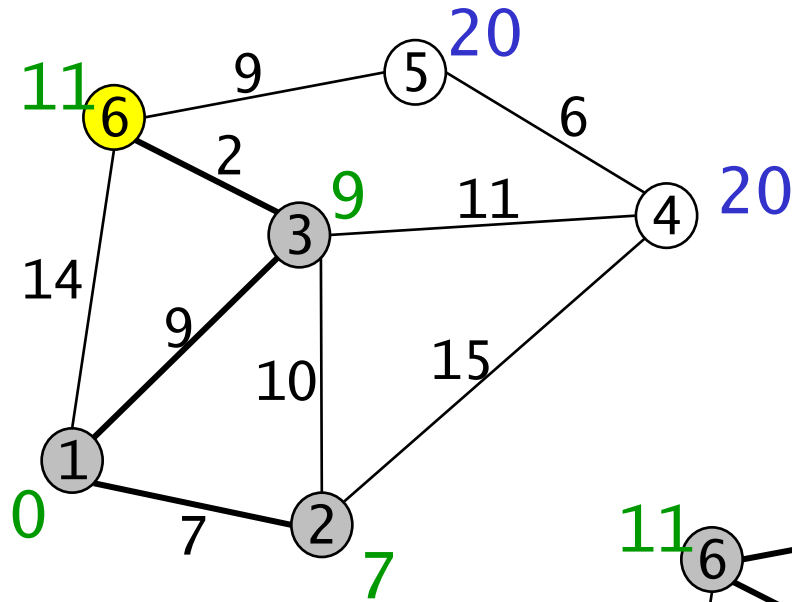

Leiden-Groningen via Maastricht?
-tweezijdig
-heuristiek

afstand? ook tijd

géén negatieve 'afstanden'
alle afstanden **Floyd**

datastructuren 'heap'

↳ standaard:

graaf adj-lists, kanttakken array

kanttakken initialiseren	$\mathcal{O}(n)$
kandidaten aanpassen	$\mathcal{O}(e)$
minimale kandidaat bepalen	$\mathcal{O}(n^2)$
	<hr/>
	$\mathcal{O}(n^2)$

↳ variant:

kanttakken óók in heap

kanttakken initialiseren	$\mathcal{O}(n)$
kandidaten aanpassen	$\mathcal{O}(e \cdot \lg n)$
minimale kandidaat bepalen	$\mathcal{O}(n \cdot \lg n)$
	<hr/>
	$\mathcal{O}(e \cdot \lg n)$

fibonacci queue $\mathcal{O}(n \cdot \lg n + e)$ AMORTIZED

II. E.W.Dijkstra



ProRail Monopoly !

“ De straten op het speelbord zijn vervangen door de belangrijkste treinstations in Nederland. De Kans- en Algemeen Fondskaarten zijn ook aangepast. ”

http://www.identitygames.nl/spellen/bedrijven/cadeauspellen/prorail_-_monopoly/

Edsger wybe Dijkstra (1930–2002)

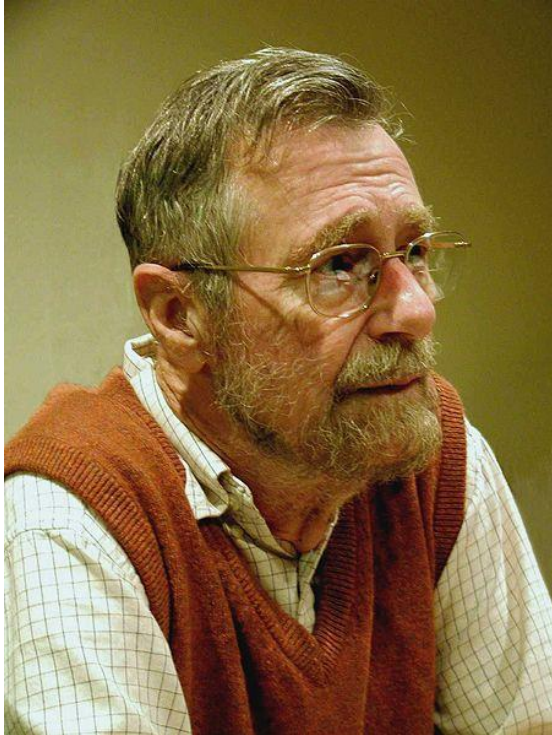

wikipedia

gestructureerd programmeren

1952 Mathematisch Centrum
wetenschappelijk programmeur

compiler voor Algol-60 ‘baard’

1957 **kortstepadagoritme**

1962 TU Eindhoven (THE)

1972 **Turing Award**

1982 Burroughs Corporation

1984 Univ. Texas te Austin

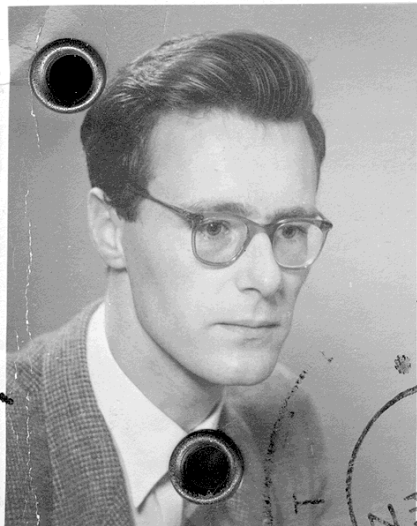

RIJKSUNIVERSITEIT TE LEIDEN

STUDIEJAAR 1954—1955

No. 0459

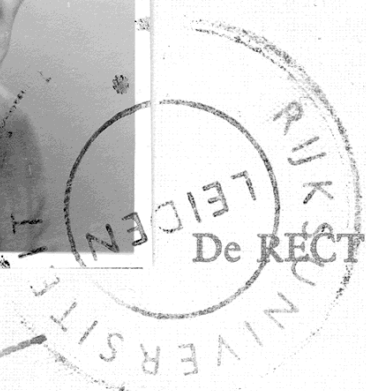

De RECTOR MAGNIFICUS verklaart, dat

mej.

E. W. Dijkstra

de heer

als STUDENT is ingeschreven en mitsdien gedurende bovenvermeld studiejaar toegang heeft tot alle lessen der Rijksuniversiteiten, alsmede tot de daarbij behorende inrichtingen en verzamelingen.

Leiden

23 Sep. 1954

[Handtekening van de ingeschrevene (ne varietur)]

[Handwritten signature]

A. Bakhuizen van den Brink

A

De ingeschrevene is verplicht deze kaart bij zich te hebben wanneer hij/zij aan college, inrichting of verzameling bezoekt en hem op verzoek van een controlerend ambtens te tonen.



“Computer science is no more about computers than astronomy is about telescopes.”

“The question of whether computers can think is like the question of whether submarines can swim.”

structured programming

Go-to statement considered harmful

CACM 11 (1968) 147-148

“A Case against the GO TO Statement”



“On the cruelty of really teaching computer science”
december 1988

A number of these phenomena have been bundled under the name “Software Engineering”. As economics is known as “The Miserable Science”, software engineering should be known as “The Doomed Discipline”, doomed because it cannot even approach its goal since its goal is self-contradictory. Software engineering, of course, presents itself as another worthy cause, but that is eyewash: if you carefully read its literature and analyse what its devotees actually do, you will discover that software engineering has accepted as its charter “How to program if you cannot.”

software engineering:

“the doomed discipline”

“how to program if you cannot”

III. handelsreiziger

rondreis!
alle plaatsen één keer



Der Handlungsreisende – wie er sein soll und was er zu thun hat, um Aufträge zu erhalten und eines glücklichen Erfolgs in seinen Geschäften gewiß zu sein (1832)

85,900 cities in a VLSI application

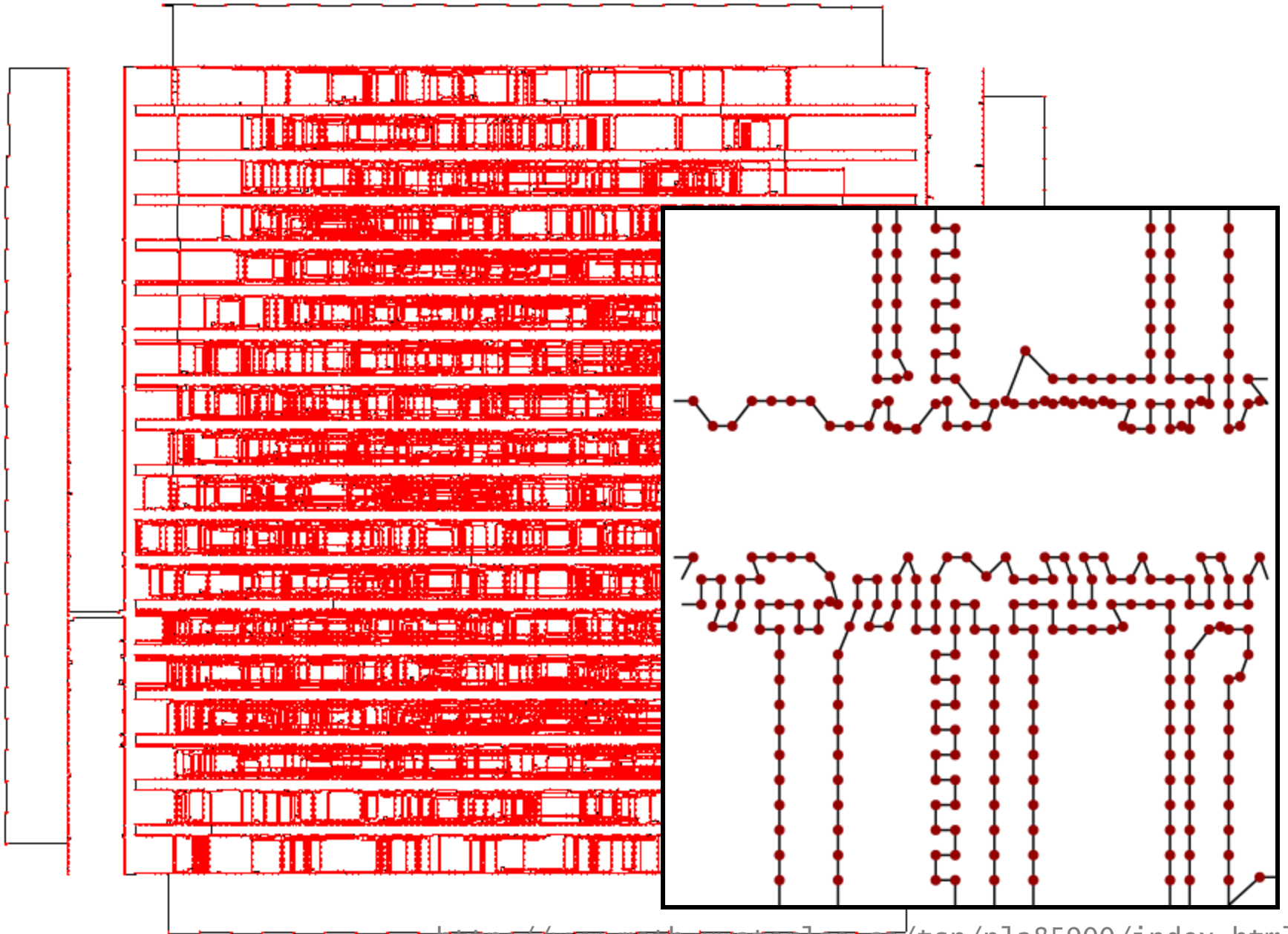

15-Year Race

Date	Tour Length	Research Team	Method
07.06.1991	142,514,146	David Johnson	Iterated Lin-Kernighan
29.03.1996	142,487,006	Concorde	Tour Merging
23.09.1997	142,482,068	Concorde	Tour Merging
14.10.1998	142,416,327	Keld Helsgaun	LKH
22.10.1999	142,409,553	Concorde	Tour Merging
18.06.2001	142,406,493	Keld Helsgaun	LKH
27.06.2001	142,405,532	Keld Helsgaun	LKH
31.08.2001	142,395,130	Concorde	Tour Merging with LKH
14.12.2001	142,393,738	Keld Helsgaun	LKH
15.09.2002	142,385,237	Hisao Tamaki	Approximate Tour Merging
12.12.2002	142,383,704	Keld Helsgaun	LKH
19.03.2003	142,383,467	Nguyen Hung	Hybrid Genetic Algorithm
28.04.2003	142,383,189	Keld Helsgaun	LKH
23.12.2003	142,383,011	Keld Helsgaun	LKH
02.05.2004	142,382,641	Keld Helsgaun	LKH

$$(142.514.146 - 142.382.641) / 142.382.641 = 0,00092360275 < 0,1\%$$

Millennium Prize Problems

- Birch & Swinnerton-Dyer Conject.
- Hodge Conjecture
- Navier-Stokes Equations
- **P vs NP** opwinding in 2014 kazachstan
- **Poincaré Conjecture** ✓ (Perelman)
- Riemann Hypothesis
- Yang-Mills Theory

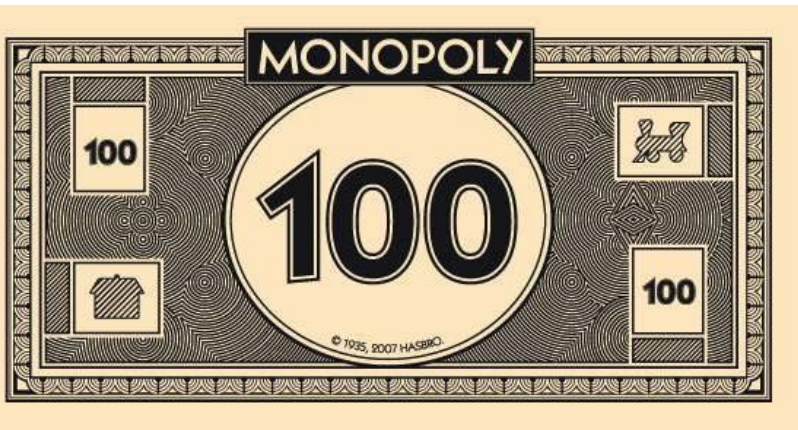

P (easy to find)

versus

NP (easy to check)

problem

Stephen Cook / Leonid Levin (1971)

NP complete

travelling salesman problem

exact vs. benadering 'heuristiek'

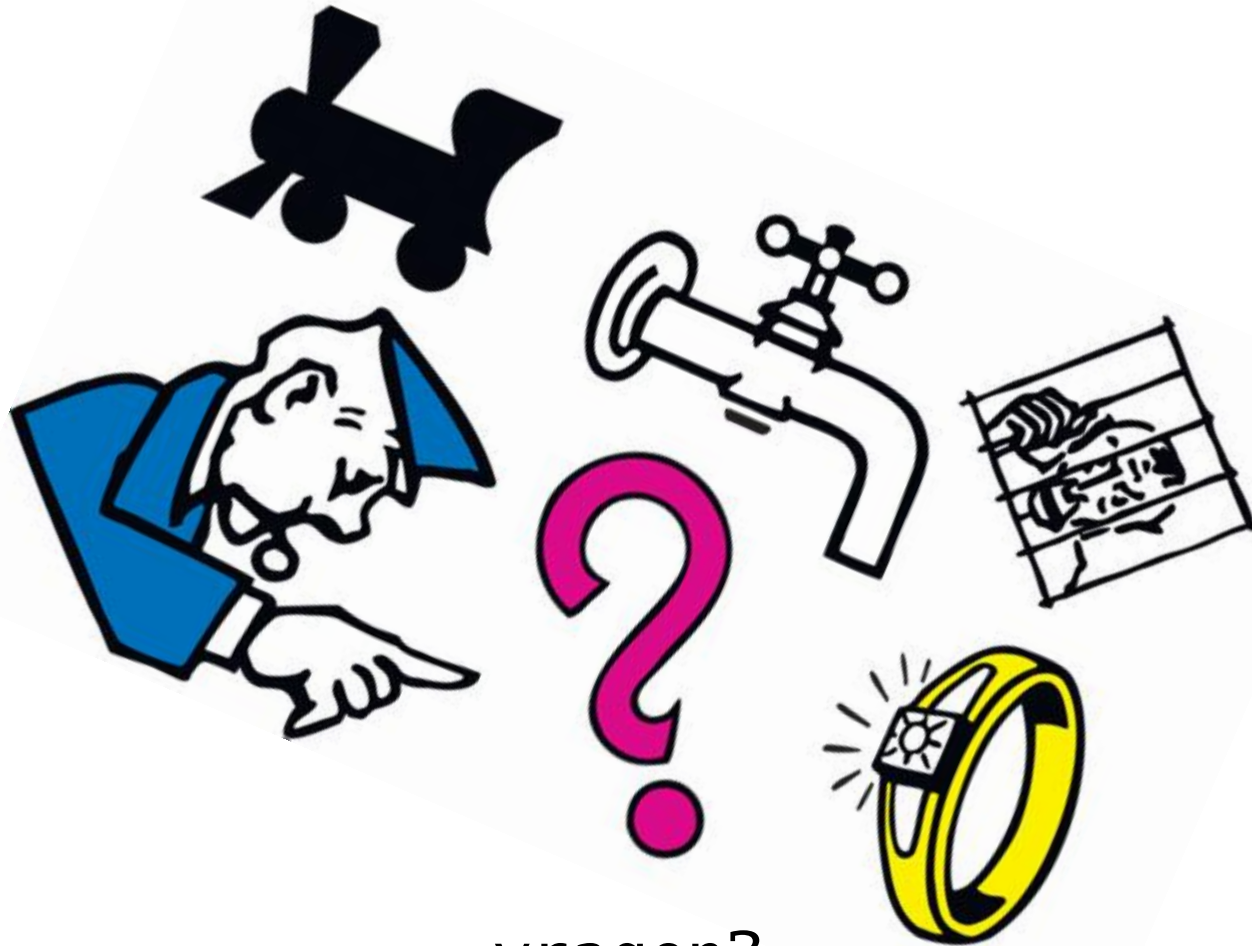

vragen?